

TECHNISCHE DATEN

ROLF BENZ 310



**ROLF
BENZ**

- Holz-Innengestell
- Stahlwellen-Unterfederung
- Rücken aus Polyurethanschaum
- Sitz aus Polyurethanschaum, schichtweise aufgebaut in verschiedenen Höhen und Härten aufeinander abgestimmt
- Bezug mit Polyester-Vlies untersteppt
- Spange Metall, wahlweise:
 - Edelstahl
 - Stahl glatt pulverbeschichtet matt RAL 9017 Verkehrsschwarz

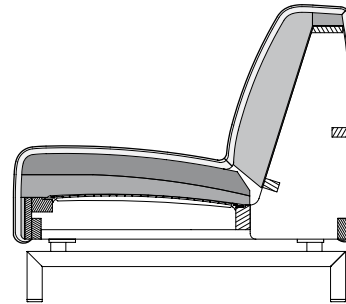

! Wellenbildung und Sitzspiegel sind aus Komfort- und Designgründen auch bei hochwertigen Polstermöbln nicht zu vermeiden.
 ■ Alle Maße sind ca.-Angaben.

Sessel

Sofabank

Sitzhöhen lieferbar

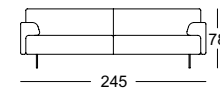
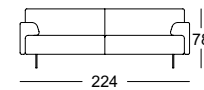
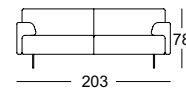
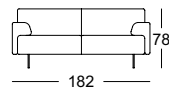
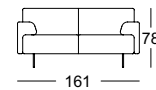
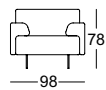
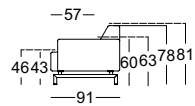
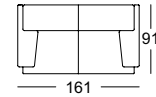
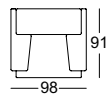
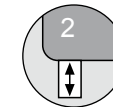

**ROLF
BENZ**

Anreihsofa*

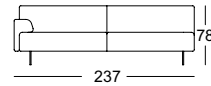
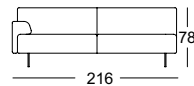
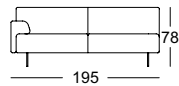
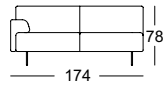
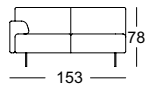
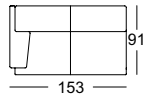

Eck-Anreihsofa*

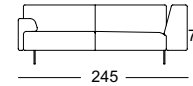
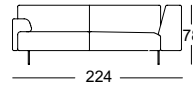
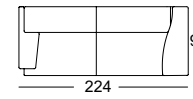

Anreihbank



Eck-Anreihbank*

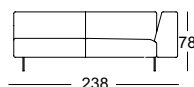
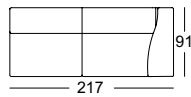

Anreihbank mit Polstersitz*

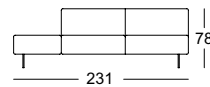
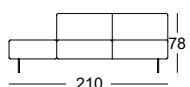
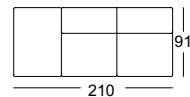

Eck-Anreihbank mit Polstersitz*

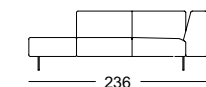
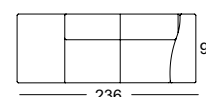

Polsterbank

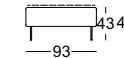
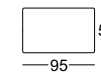
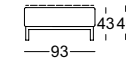

Hocker

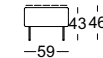
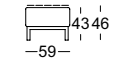

Kombinationsbeispiele:

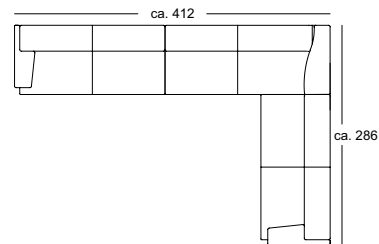

ASO 310/195 li.
E-ARB 310/217 li.
ASO 310/195 re.

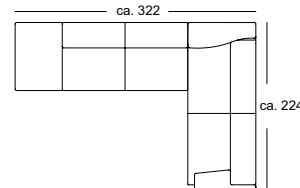

ARB-PSZ 310/231 li.
E-ASO 310/224 re.

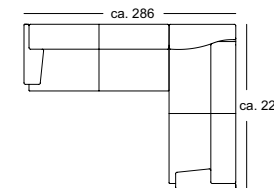

ASO 310/195 re.
E-ASO 310/224 li.

*Diese Elemente sind in ihrer linken Ausführung abgebildet. Sie sind aber auch gespiegelt in der rechten Ausführung verfügbar.