

cierre

living in leather

clift/ divano
scheda prodotto

clift/ sofa
product details

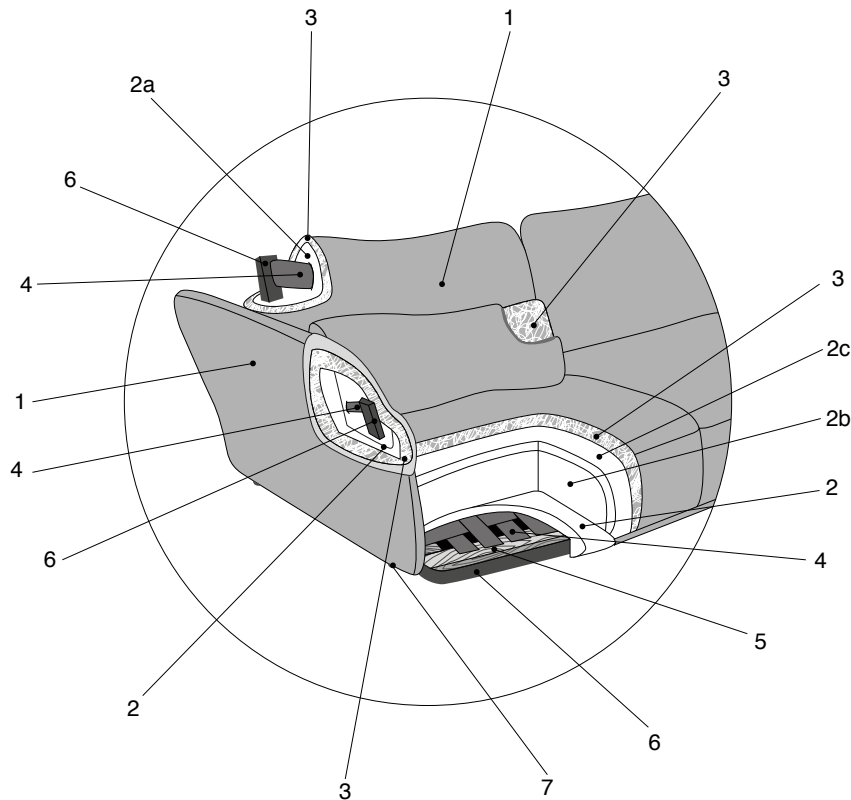

composizione

- 1_rivestimento
- 2_imbottitura della struttura in poliuretano espanso a densità differenziata da 18 a 120 kg/m³
- 2a_imbottitura dello schienale in poliuretano espanso a densità differenziata da 21 a 120 kg/m³ tipi di materiale 6
- 2b_imbottitura della seduta in poliuretano espanso a densità differenziata da 18 a 35 kg/m³ tipi di materiale 4
- 2c_imbottitura della seduta in memory
- 3_imbottitura in falda acrilica
- 4_nastri elastici
- 5_struttura in legno massello di abete
- 6_struttura in ferro
- 7_piede in polimero nero

caracteristiques

- 1_revêtement
- 2_garnissage de la carcasse en mousse polyuréthane expansée avec densités différenciées de 18 à 120 kg/m³
- 2a_garnissage du dossier en mousse polyuréthane expansée avec densités différenciées de 21 à 120 kg/m³ : 6 types de mousses
- 2b_garnissage de l'assise en mousse polyuréthane expansée à densités différenciées de 18 à 35 kg/m³ : 4 types de mousses
- 2c_assise en mousse memory
- 3_garnissage en couche de fibres acryliques
- 4_sangles élastiques
- 5_panneau en bois de sapin massif
- 6_structure en métal
- 7_pied en plastique noire

materials

- 1_cover
- 2_frame upholstered with expanded polyurethane foam in different densities from 18 to 120 kg/m³
- 2a_backrest cushion upholstery in polyurethane foam with different densities from 21 to 120 kg/m³, 6 types of foams
- 2b_seat cushions upholstery in polyurethane foam with different densities from 18 to 35 kg/m³, 4 types of foams
- 2c_seat cushions in memory foam
- 3_acrylic padding
- 4_elastic belts
- 5_frame in solid fir wood
- 6_metal frame
- 7_black plastic leg

materialien

- 1_bezug
- 2_polsterung aus Polyurethanschaum mit unterschiedlicher Dichte von 18 bis 120 kg/m³:
- 2a_rückenkissenpolsterung aus Polyurethanschaum mit unterschiedlicher Dichte von 21 bis 120 kg/m³: 6 verschiedene Schaumstoffarten
- 2b_sitzkissenpolsterung aus Polyurethanschaum mit unterschiedlicher Dichte von 18 bis 35 kg/m³: 4 verschiedene Schaumstoffarten
- 2c_sitzkissen in Memory Schaum
- 3_acrylpolsterung
- 4_hochelastische Gurtbänder
- 5_stuktur aus Fichtenholz massiv
- 6_metallgestell
- 7_fuß aus schwarzem Kunststoff

cierre imbottiti srl

via giovanni ansaldo, 2
47122 villa selva, forlì (fc), italy
t. (+39) 0543 785911
f. (+39) 0543 782493
info@cierreimbottiti.com

www.cierreimbottiti.com



designer: Marco Fumagalli

2_2 seater sofa

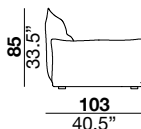
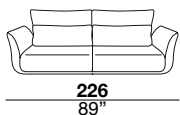

3_3 seater sofa

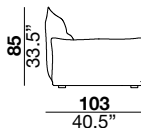
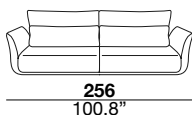

SX_extra large sofa

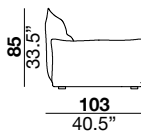
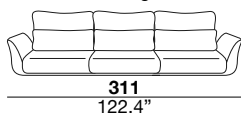

07_2 seater left arm | 08_2 seater right arm

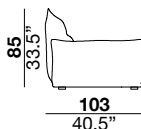
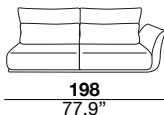
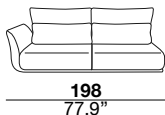

19_3 seater left arm | 20_3 seater right arm

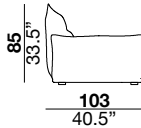
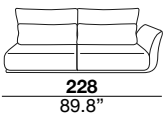
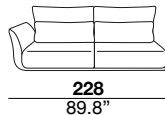

09_3 seater left arm | 10_3 seater right arm

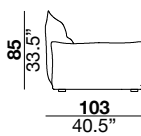
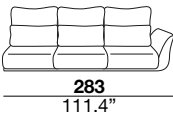
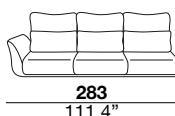

17_long-chair left arm | 18_long-chair right arm

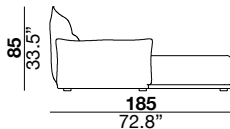
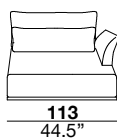
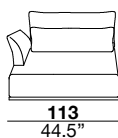

01B_1 seat with arm/backrest

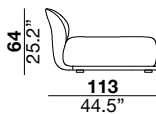
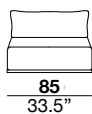

sofaprogramm mit Struktur aus Metall, Gestell aus Holz. Unterfederung aus hochelastischen Gurtbändern. Sitzkissenpolsterung aus Polyurethanschäum in drei verschiedenen Dichten, Memory Foam und Acrylfaser Abdeckung. Metallrücken- und Armlehnen sind mit Polyurethanschäumstoff überzogen und Acrylfaser Abdeckung. Füße aus schwarzem Kunststoff



designer: Marco Fumagalli

02_2 seater without arms

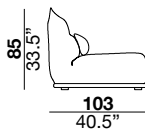
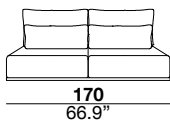

40_90° corner piece

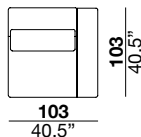
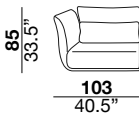

75B_1 seat with arm/backrest + footstool left side
76B1_seat with arm/backrest + footstool right side

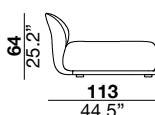
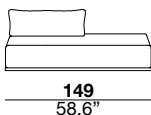
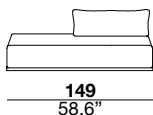

CSR_back cushion

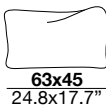

sofaprogramm mit Struktur aus Metall, Gestell aus Holz. Unterfederung aus hochelastischen Gurtbändern. Sitzkissenpolsterung aus Polyurethanschaum in drei verschiedenen Dichten, Memory Foam und Acrylfaser Abdeckung. Metallrücken- und Armlehnen sind mit Polyurethanschaumstoff überzogen und Acrylfaser Abdeckung. Füße aus schwarzem Kunststoff