

outdoor

Nude

Square dining table / mesa cuadrada

studio expormim 2018

C130



Structure made of stainless steel tube, finished with polyester powder. Tabletop options: HPL Trespa® 8 mm/0.31" thick and Dekton® 8 mm/0.31" thick. Delivered unassembled.

Estructura fabricada en tubo de acero inoxidable, acabado en pintura de polvo de poliéster. Opciones de tablero: HPL Trespa® de 8 mm y Dekton® de 8 mm. Se sirven desmontadas.

Shipment details

Qty	1 dining table (1 box)
Volume	0,15 m3 / 5.3 ft3
HPL Top option	
Gross weight	31 kg / 68.3 lb
Net weight	21 kg / 46.3 lb
Dekton Top option	
Gross weight	39 kg / 86 lb
Net weight	29 kg / 64 lb
Item dimensions (width x depth x height)	100 x 100 x 74 cm 39.25" x 39.25" x 29.25"

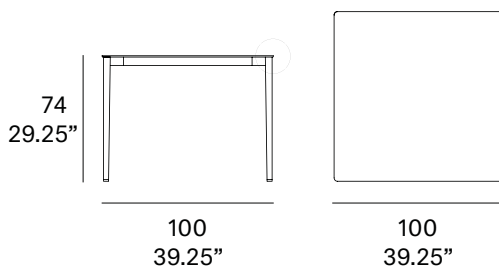

Tabletop options:

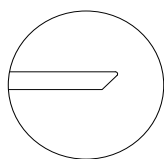

- HPL Trespa® 8 mm/0.31" thick.

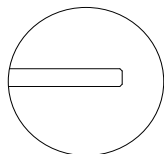

- Dekton® 8 mm/0.31" thick.

expormim

Expormim S.A.
Pol. Ind. Jaime I
46640 Moixent (Valencia) Spain
+34 962 295 144/5
export@expormim.com
www.expormim.com

Expormim USA LLC
(212) 204-8572
usa@expormim.com
www.expormim.com

1/3

outdoor

Nude

Square dining table / mesa cuadrada

studio expormim 2018

C131



Structure made of stainless steel tube, finished with polyester powder. Trespa® HPL 8 mm/0.31" thick top. Delivered unassembled.

Estructura fabricada en tubo de acero inoxidable, acabado en pintura de polvo de poliéster. Tablero de HPL Trespa® de 8 mm. Se sirven desmontadas.

Shipment details

Qty	1 dining table (1 box)
Volume	0,26 m3 / 9.2 ft3
Gross weight	63 kg / 139 lb
Net weight (x1)	43 kg / 95 lb
Item dimensions (width x depth x height)	150 x 150 x 74 cm 59" x 59" x 29.25"

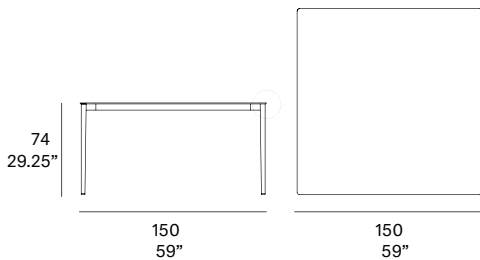

Tabletop options:

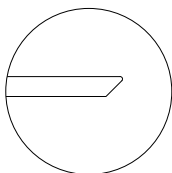

- HPL Trespa® 8 mm/0.51" thick.

expormim

Expormim S.A.
Pol. Ind. Jaime I
46640 Moixent (Valencia) Spain
+34 962 295 144/5
export@expormim.com
www.expormim.com

Expormim USA LLC
(212) 204-8572
usa@expormim.com
www.expormim.com

1/2

outdoor

Nude

Rectangular dining table / mesa rectangular

studio expormim 2018

C132



Structure made of stainless steel tube, finished with polyester powder. Tabletop options: HPL Trespa® 8 mm/0.31" thick and Dekton® 8 mm/0.31" thick. Delivered unassembled.

Estructura fabricada en tubo de acero inoxidable, acabado en pintura de polvo de poliéster. Opciones de tablero: HPL Trespa® de 8 mm y Dekton® de 8 mm. Se sirven desmontadas.

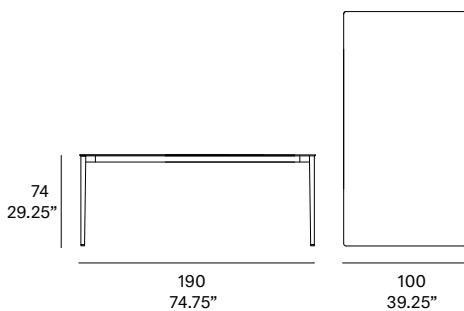

Shipment details

Qty	1 dining table (1 box)
Volume	0,21 m3 / 7.4 ft3
HPL Top option	
Gross weight	47 kg / 104 lb
Net weight	32 kg / 70.5 lb
Kerlite Top option	
Gross weight	57 kg / 126 lb
Net weight	50 kg / 110 lb
Item dimensions (width x depth x height)	190 x 100 x 74 cm 74.75" x 39.25" x 29.25"

Tabletop options:

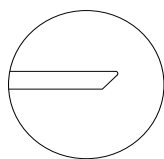

- HPL Trespa® 8 mm/0.31" thick.

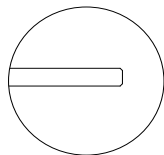

- Dekton® 8 mm/0.31" thick.

expormim

Expormim S.A.
Pol. Ind. Jaime I
46640 Moixent (Valencia) Spain
+34 962 295 144/5
export@expormim.com
www.expormim.com

Expormim USA LLC
(212) 204-8572
usa@expormim.com
www.expormim.com

1/3

outdoor

Nude

Rectangular dining table / mesa rectangular

studio expormim 2018

C133



Structure made of stainless steel tube, finished with polyester powder. Tabletop options: HPL Trespa® 8 mm/0.31" thick and Dekton® 8 mm/0.31" thick. Delivered unassembled.

Estructura fabricada en tubo de acero inoxidable, acabado en pintura de polvo de poliéster. Opciones de tablero: HPL Trespa® de 8 mm y Dekton® de 8 mm. Se sirven desmontadas.

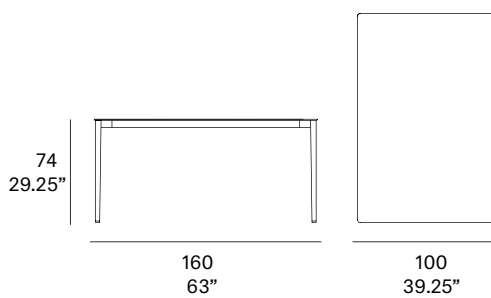

Shipment details

Qty 1 dining table (1 box)

Volume 0,20 m3 / 7 ft3

HPL Top option

Gross weight 42 kg / 92.6 lb

Net weight 27 kg / 59.5 lb

Dekton Top option

Gross weight 55 kg / 121 lb

Net weight 40 kg / 88.2 lb

Item dimensions (width x depth x height) 160 x 100 x 74 cm
63" x 39.25" x 29.25"

Tabletop options:

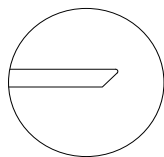

- HPL Trespa® 8 mm/0.31" thick.

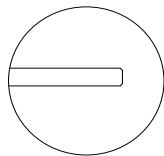

- Dekton® 8 mm/0.31" thick.

expormim

Expormim S.A.
Pol. Ind. Jaime I
46640 Moixent (Valencia) Spain
+34 962 295 144/5
export@expormim.com
www.expormim.com

Expormim USA LLC
(212) 204-8572
usa@expormim.com
www.expormim.com

1/3

outdoor

Nude

Rectangular dining table / mesa rectangular

studio expormim 2018

C134



Structure made of stainless steel tube, finished with polyester powder. Tabletop options: HPL Trespa® 8 mm/0.31" thick and Dekton® 8 mm/0.31" thick. Delivered unassembled.

Estructura fabricada en tubo de acero inoxidable, acabado en pintura de polvo de poliéster. Opciones de tablero: HPL Trespa® de 8 mm y Dekton® de 8 mm. Se sirven desmontadas.

Shipment details

Qty 1 dining table (1 box)

Volume 0,26 m3 / 9.2 ft3

HPL Top option

Gross weight 58 kg /128 lb

Net weight 38 kg / 84 lb

Dekton Top option

Gross weight 81 kg / 179 lb

Net weight 60 kg / 132 lb

Item dimensions (width x depth x height) 220 x 100 x 74 cm
86.5" x 39.25" x 29.25"

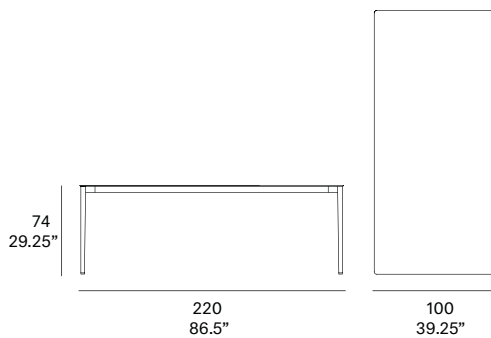

Tabletop options:

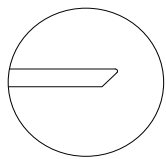

- HPL Trespa® 8 mm/0.31" thick.

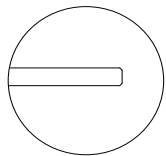

- Dekton® 8 mm/0.31" thick.

expormim

Expormim S.A.
Pol. Ind. Jaime I
46640 Moixent (Valencia) Spain
+34 962 295 144/5
export@expormim.com
www.expormim.com

Expormim USA LLC
(212) 204-8572
usa@expormim.com
www.expormim.com

1/3

outdoor

Nude Rectangular dining table / mesa rectangular

studio expormim 2018

C135



Structure made of stainless steel tube, finished with polyester powder. Tabletop options: HPL Trespa® 8 mm/0.31" thick and Dekton® 8 mm/0.31" thick. Delivered unassembled.

Estructura fabricada en tubo de acero inoxidable, acabado en pintura de polvo de poliéster. Opciones de tablero: HPL Trespa® de 8 mm y Dekton® de 8 mm. Se sirven desmontadas.

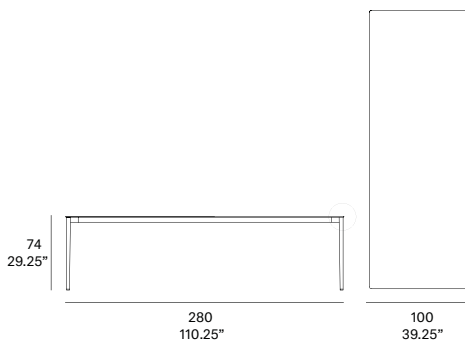

Shipment details

Qty	1 dining table (1 box)
Volume	0,35 m3 / 12.4 ft3

HPL Top option

Gross weight	73 kg / 161 lb
Net weight	53 kg / 117 lb

Dekton Top option

Gross weight	95 kg / 209 lb
Net weight	75 kg / 165 lb

Item dimensions (width x depth x height)	280 x 100 x 74 cm 110.25" x 39.25" x 29.25"
---	--

Tabletop options:

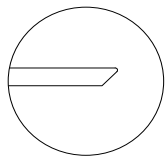

- HPL Trespa® 8 mm/0.31" thick.

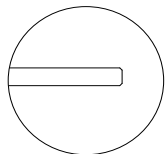

- Dekton® 8 mm/0.31" thick.

expormim

Expormim S.A.
Pol. Ind. Jaime I
46640 Moixent (Valencia) Spain
+34 962 295 144/5
export@expormim.com
www.expormim.com

Expormim USA LLC
(212) 204-8572
usa@expormim.com
www.expormim.com

1/2

outdoor

Nude

Rectangular dining table / mesa rectangular

studio expormim 2018

C136



Structure made of stainless steel tube, finished with polyester powder. Tabletop options: HPL Trespa® 8 mm/0.31" thick and Dekton® 8 mm/0.31" thick. Delivered unassembled.

Estructura fabricada en tubo de acero inoxidable, acabado en pintura de polvo de poliéster. Opciones de tablero: HPL Trespa® de 8 mm y Dekton® de 8 mm. Se sirven desmontadas.

Shipment details

Qty 1 dining table (1 box)

Volume 0,28 m3 / 9.9 ft3

HPL Top option

Gross weight 65 kg / 143 lb

Net weight 42 kg / 92.6 lb

Kerlite Top option

Gross weight 95 kg / 209 lb

Net weight 70 kg / 154 lb

Item dimensions (width x depth x height) 250 x 100 x 74 cm
98.5" x 39.25" x 29.25"

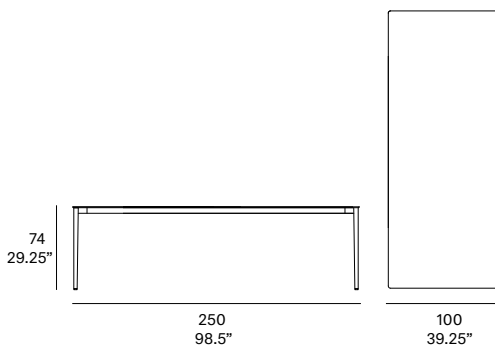

Tabletop options:

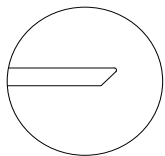

- HPL Trespa® 8 mm/0.31" thick.

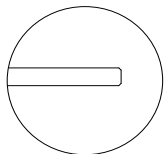

- Dekton® 8 mm/0.31" thick.

expormim

Expormim S.A.
Pol. Ind. Jaime I
46640 Moixent (Valencia) Spain
+34 962 295 144/5
export@expormim.com
www.expormim.com

Expormim USA LLC
(212) 204-8572
usa@expormim.com
www.expormim.com

1/3

outdoor

Nude Round dining table / mesa redonda

studio expormim 2018

C137



Structure made of stainless steel tube, finished with polyester powder. Tabletop options: HPL Trespa® 8 mm/0.31" thick and Dekton® 8 mm/0.31" thick. Delivered unassembled.

Estructura fabricada en tubo de acero inoxidable, acabado en pintura de polvo de poliéster. Opciones de tablero: HPL Trespa® de 8 mm y Dekton® de 8 mm. Se sirven desmontadas.

Shipment details

Qty	1 dining table (1 box)
Volume	0,15 m3 / 5.3 ft3

HPL Top option

Gross weight	29 kg / 64 lb
Net weight	19 kg / 42 lb

Dekton Top option

Gross weight	36 kg / 79.5 lb
Net weight	26 kg / 57.3 lb

Item dimensions (width x depth x height)	98 x 98 x 74 cm 38.5" x 38.5" x 29.25"
---	---

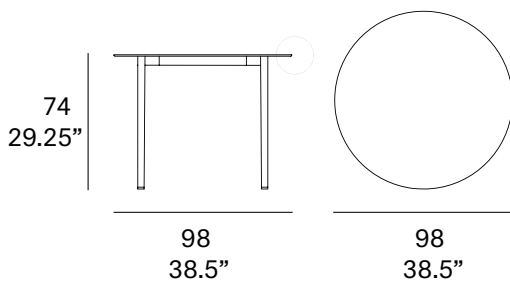

Tabletop options:

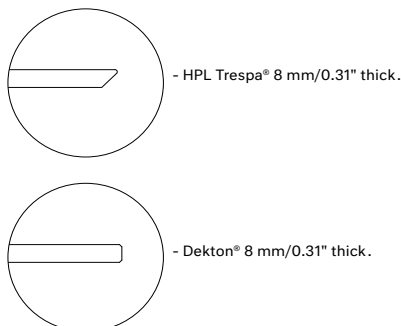

expormim

Expormim S.A.
Pol. Ind. Jaime I
46640 Moixent (Valencia) Spain
+34 962 295 144/5
export@expormim.com
www.expormim.com

Expormim USA LLC
(212) 204-8572
usa@expormim.com
www.expormim.com

1/3

outdoor

Nude Round dining table / mesa redonda

studio expormim 2018

C138



Structure made of stainless steel tube, finished with polyester powder. Trespa® HPL 13 mm/0.51" thick top. Delivered unassembled.

Estructura fabricada en tubo de acero inoxidable, acabado en pintura de polvo de poliéster. Tablero de HPL Trespa® de 13 mm. Se sirven desmontadas.

Shipment details

Qty	1 dining table (1 box)
Volume	0,26 m3 / 9.2 ft3
Gross weight	62 kg / 137 lb
Net weight (x1)	42 kg / 92.6 lb
Item dimensions (width x depth x height)	150 x 150 x 74 cm 59" x 59" x 29.25"

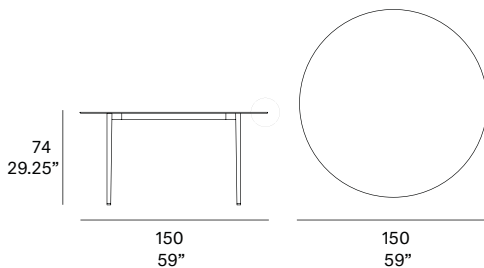

Tabletop options:

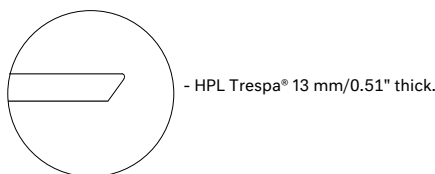

expormim

Expormim S.A.
Pol. Ind. Jaime I
46640 Moixent (Valencia) Spain
+34 962 295 144/5
export@expormim.com
www.expormim.com

Expormim USA LLC
(212) 204-8572
usa@expormim.com
www.expormim.com

1/2

outdoor

Nude

Rectangular expandable dining table / mesa rectangular extensible

studio expormim 2018

C140



Structure made of stainless steel tube, finished with polyester powder. Trespa® HPL 13 mm/0.51" thick top. Delivered unassembled.

Estructura fabricada en tubo de acero inoxidable, acabado en pintura de polvo de poliéster. Tablero de HPL Trespa® de 13 mm. Se sirven desmontadas.

Shipment details

Qty 1 dining table (1 box)

Volume 0,40 m3 / 14.1 ft3

HPL Top option

Gross weight 110 kg / 243 lb

Net weight 90 kg / 198 lb

Item dimensions (width x depth x height) 220 x 100 x 74 cm
86.5" x 39.25" x 29.25"

280 x 100 x 74 cm
110.25" x 39.25" x 29.25"

340 x 100 x 74 cm
133.75" x 39.25" x 29.25"

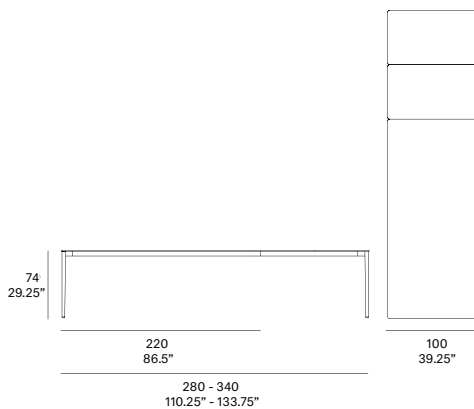

Tabletop options:

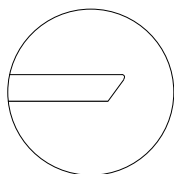

- HPL Trespa® 13 mm/0.51" thick.

expormim

Expormim S.A.
Pol. Ind. Jaime I
46640 Moixent (Valencia) Spain
+34 962 295 144/5
export@expormim.com
www.expormim.com

Expormim USA LLC
(212) 204-8572
usa@expormim.com
www.expormim.com

1/2

outdoor

frame / estructura

metallic finishes / metales



100 white



102 FT light grey
fine textured



111 FT graphite
fine textured



108 FT oxide
fine textured



109 FT champagne
fine textured



110 FT bronze
fine textured

outdoor

top / tapa

HPL Trespa® - premium



320 silver quartzite - matt



321 italian slate - matt



327 titanium bronze - satin

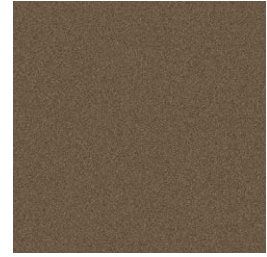

328 urban brown - satin

HPL Trespa® - basic



300 white

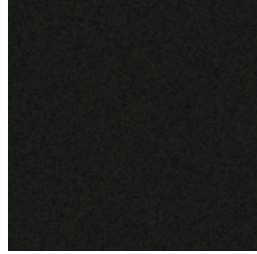

301 black

Dekton®



D3 danae



D4 keon



D2 kelya