

# cierre

living in leather

**season/** divano  
scheda prodotto

---

**season/** sofa  
product details

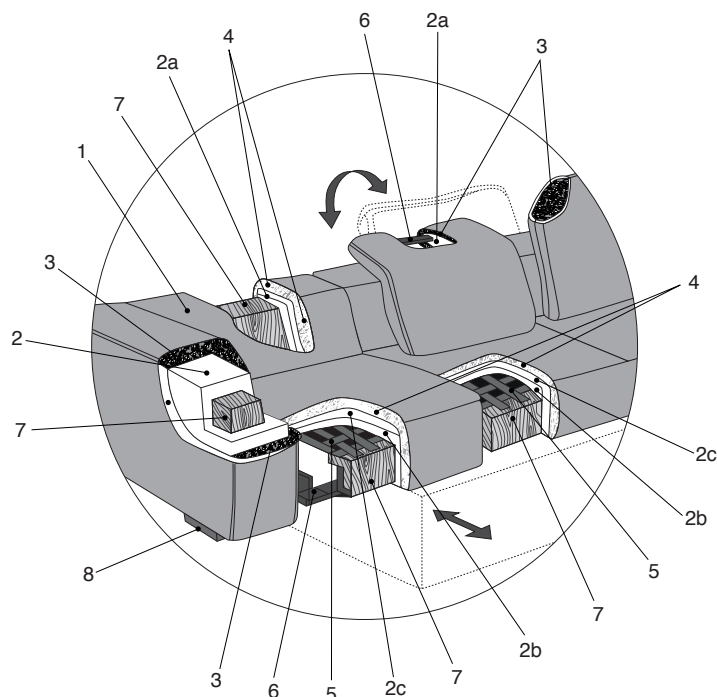

## composizione

### 1\_rivestimento

2\_imbottitura della struttura in poliuretano espanso a densità differenziata da 30 a 55 kg/m<sup>3</sup>

2a\_imbottitura dello schienale in poliuretano espanso a densità differenziata da 18 a 40 kg/m<sup>3</sup> tipi di materiale 6

2b\_imbottitura della seduta in poliuretano espanso a densità differenziata da 40 a 55 kg/m<sup>3</sup> tipi di materiale 4

2c\_imbottitura della seduta in memory

3\_imbottitura in piuma d'oca sterilizzata antiallergica

4\_imbottitura in falda acrilica

5\_nastri elastici

6\_struttura in ferro

7\_struttura in multistrati di pioppo

8\_piede in massello di faggio

**il modello può essere dotato di meccanismo per l'avanzamento della seduta. Lo schienale CSM è dotato di un meccanismo che permette di regolare le posizioni**

## caracteristiques

### 1\_revêtement

2\_garnissage de la carcasse en mousse polyuréthane expansée avec densité différentes de 30 à 55 kg/m<sup>3</sup>

2a\_garnissage du dossier en mousse polyuréthane expansée avec densité différentes de 18 à 40 kg/m<sup>3</sup> : 6 types de mousse

2b\_garnissage de l'assise en mousse polyuréthane expansée à densité différentes de 40 à 55 kg/m<sup>3</sup> : 4 types de mousse

2c\_assise en mousse memory

3\_garnissage en plumes d'oie stérilisées antiallergiques

4\_garnissage en fibres acryliques

5\_sangles élastiques

6\_structure en métal

7\_structure en multiplies de peuplier

8\_pied en bois de hêtre massif

**le modèle est disponible avec un mécanisme qui permet d'avancer l'assise et avoir différents profondeurs. Le coussin de dos CSM est doté d'un mécanisme réglable**

## materials

### 1\_cover

2\_frame upholstered with expanded polyurethane foam in different densities from 30 a 55 kg/m<sup>3</sup>

2a\_back cushions upholstery is in polyurethane foam in different densities from 18 a 40 kg/m<sup>3</sup> ,6 types of foams

2b\_seat cushions upholstery is in polyurethane foam in different densities from 40 to 55 kg/m<sup>3</sup>: 4 types of foams

2c\_seat cushions in memory foams

3\_sterilized hypoallergenic goose-down

4\_acrylic padding

5\_elastic belts

6\_metal frame

7\_frame in multilayer poplar

8\_leg in solid beech wood

**this model is also available with a mechanism in the seat that allows you to have different depth. The back cushion CSM is equipped with a mechanism that allows you to adjust the position to get the highest comfort**

## materialien

### 1\_bezug

2\_polsterung aus Polyurethanschaum mit unterschiedlicher Dichte von 30 bis 55 kg/m<sup>3</sup>

2a\_rückenkissenpolsterung aus Polyurethanschaum mit unterschiedlicher Dichte von 18 bis 40 kg/m<sup>3</sup>: 6 verschiedene Schaumstoffarten

2b\_sitzkissenpolsterung aus Polyurethanschaum mit unterschiedlicher Dichte von 40 bis 55 kg/m<sup>3</sup>: 4 verschiedene Schaumstoffarten

2c\_sitzkissen in Memory Schäume

3\_polsterung aus sterilisierter, antiallergischen Gänsedaune

4\_acrylpolsterung

5\_hochelastische Gurtbänder

6\_metallgestell

7\_struktur aus Mehrschichtspanplatte aus Pappelholz

8\_Fuß aus Buchenholz Massiv

**eine mechanisierte Version ist ebenfalls verfügbar, die 2 Sitztiefen ermöglicht. Das Rückenkissen CSM ist mit einem Mechanismus ausgestattet, mit dem die Position verstellt werden kann**

**cierre imbottiti srl**

via giovanni ansaldo, 2  
47122 villa selva, forlì (fc), italy  
t. (+39) 0543 785911  
f. (+39) 0543 782493  
info@cierreimbottiti.com

---

[www.cierreimbottiti.com](http://www.cierreimbottiti.com)



designer: studio tecnico Cierre

1FA\_armchair high back

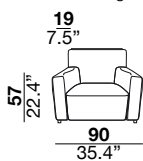

1GO\_armchair with tilting mech.

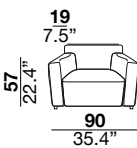
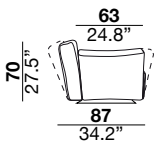

1OA\_armchair w. tilting mech./high back

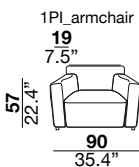
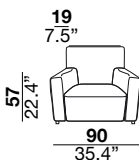
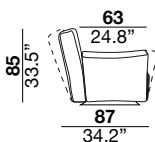

PRP\_lumbar pillow for armchair

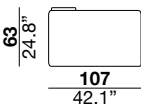
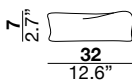

1S\_1 seat left arm  
(arm cm 33)

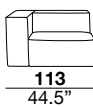

2S\_1 seat right arm  
(arm cm 33)

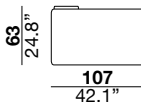
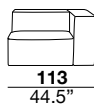

3S\_1 seat left arm  
(arm cm 33)

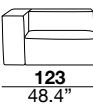

4S\_1 seat right arm  
(arm cm 33)

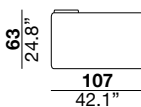
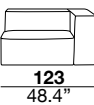

5S\_1 seat left arm  
(arm cm 33)

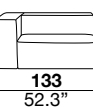

6S\_1 seat right arm  
(arm cm 33)

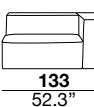

divano modulare con struttura di seduta in legno e supporto di nastri elastici, rivestito in poliuretano espanso a 3 densità ed uno strato di Memory foam. È disponibile anche una versione meccanizzata, che permette l'avanzamento della seduta, aumentando la profondità. Lo schienale e i braccioli sono in legno rivestiti in poliuretano espanso e piuma d'oca anallergica. I piedi sono in legno verniciato nero.



designer: studio tecnico Cierre

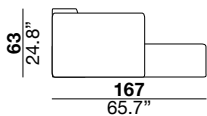

17S\_longchair left arm  
(arm cm 33)

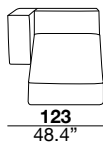

18S\_longchair right arm  
(arm cm 33)

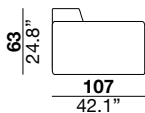
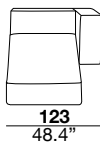

1L\_1 seat left arm  
(arm cm 45)

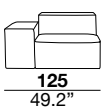

2L\_1 seat right arm  
(arm cm 45)

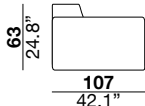
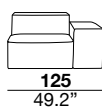

3L\_1 seat left arm  
(arm cm 45)

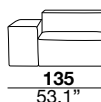

4L\_1 seat right arm  
(arm cm 45)

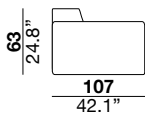
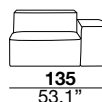

5L\_1 seat left arm  
(arm cm 45)

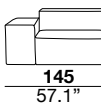

6L\_1 seat right arm  
(arm cm 45)

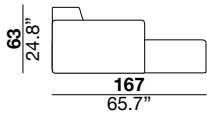
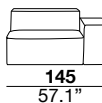

17L\_longchair left arm  
(arm cm 33)

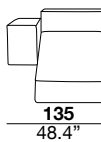

18L\_longchair right arm  
(arm cm 33)

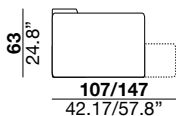
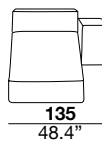

1SM\_1 seat left arm  
(arm cm 33)

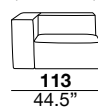

2SM\_1 seat right arm  
(arm cm 33)

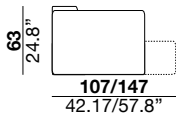
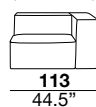

3SM\_1 seat left arm  
(arm cm 33)

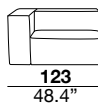

4SM\_1 seat right arm  
(arm cm 33)

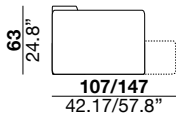
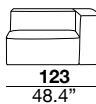

5SM\_1 seat left arm  
(arm cm 33)

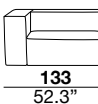

6SM\_1 seat right arm  
(arm cm 33)

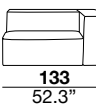

divano modulare con struttura di seduta in legno e supporto di nastri elastici, rivestito in poliuretano espanso a 3 densità ed uno strato di Memory foam. È disponibile anche una versione meccanizzata, che permette l'avanzamento della seduta, aumentando la profondità. Lo schienale e i braccioli sono in legno rivestiti in poliuretano espanso e piuma d'oca anallergica. I piedi sono in legno verniciato nero.



designer: studio tecnico Cierre

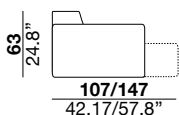

1LM\_1 seat left arm  
(arm cm 45)

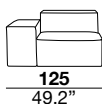

2LM\_1 seat right arm  
(arm cm 45)

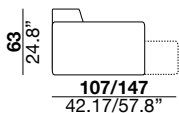
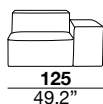

3LM\_1 seat left arm  
(arm cm 45)

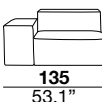

4LM\_1 seat right arm  
(arm cm 45)

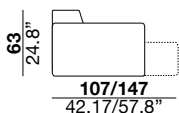
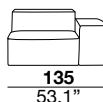

5LM\_1 seat left arm  
(arm cm 45)

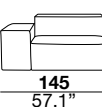

6LM\_1 seat right arm  
(arm cm 45)

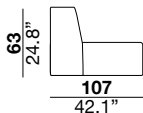
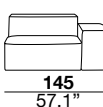

CP\_small armless unit

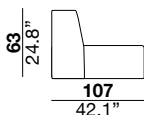
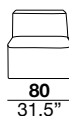

C\_armless unit

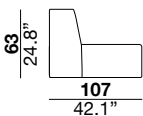
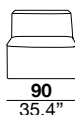

CG\_large armless unit

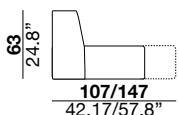
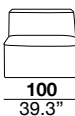

CPM\_small armless  
unit w. mech

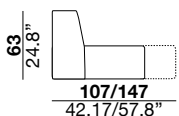
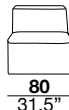

CM\_armless unit  
w. mech

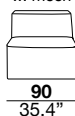

divano modulare con struttura di seduta in legno e supporto di nastri elastici, rivestito in poliuretano espanso a 3 densità ed uno strato di Memory foam. È disponibile anche una versione meccanizzata, che permette l'avanzamento della seduta, aumentando la profondità. Lo schienale e i braccioli sono in legno rivestiti in poliuretano espanso e piuma d'oca anallergica. I piedi sono in legno verniciato nero.



designer: studio tecnico Cierre

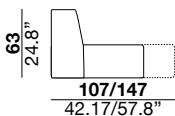

CGM\_large armless  
unit w. mech

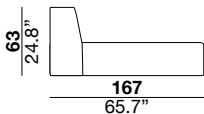
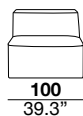

33\_longchair without arms

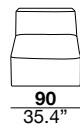

40\_90° corner piece

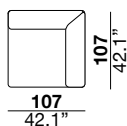

PPR\_small rectangular ottoman

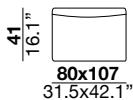

PRT\_rectangular ottoman

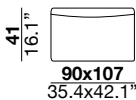

P\_large rectangular ottoman

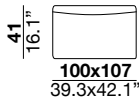

CS\_back cushion



CSM\_back cushion w. mech



divano modulare con struttura di seduta in legno e supporto di nastri elastici, rivestito in poliuretano espanso a 3 densità ed uno strato di Memory foam. È disponibile anche una versione meccanizzata, che permette l'avanzamento della seduta, aumentando la profondità. Lo schienale e i braccioli sono in legno rivestiti in poliuretano espanso e piuma d'oca anallergica. I piedi sono in legno verniciato nero.