

cierre

living in leather

merlino/ divano
scheda prodotto

merlino/ sofa
product details

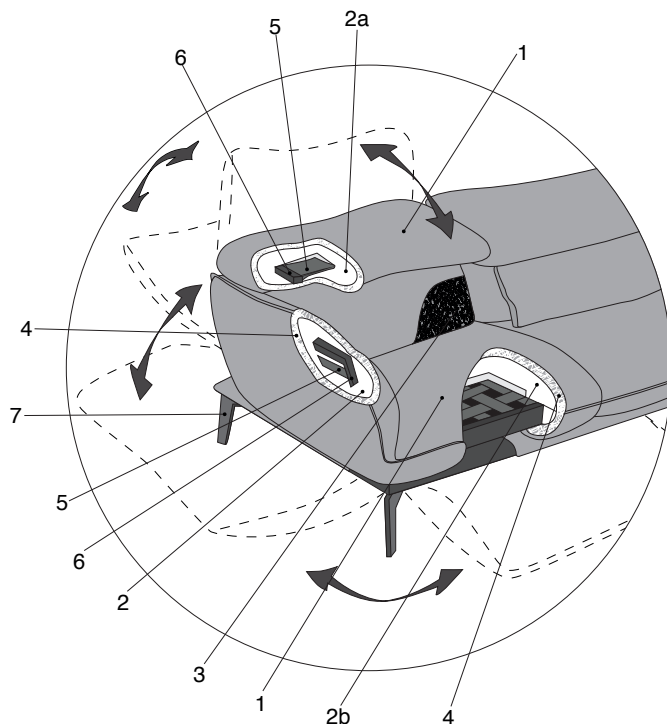

composizione

- 1_rivestimento
- 2_imbottitura della struttura in poliuretano espanso a densità differenziata da 25 a 110 kg/m³, tipi di materiali 2
- 2a_imbottitura dello schienale in poliuretano espanso a densità differenziata da 25 a 30 kg/m³, tipi di materiali 3
- 2b_imbottitura della seduta in poliuretano espanso a densità differenziata da 35 a 110 kg/m³, tipi di materiali 2
- 3_imbottitura in piuma d'oca sterilizzata anallergica
- 4_imbottitura in falda acrilica
- 5_nastri elastici
- 6_struttura in metallo
- 7_piede in metallo cromato nero

il modello è composto da una serie di meccanismi che trasformano e aumentano la capacità di confort

caracteristiques

- 1_revêtement
- 2_garnissage de la carcasse en mousse polyuréthane expansée avec densité différentes de 25 à 110 kg/m³ : 2 types différents de mousse
- 2a_garnissage du dossier en mousse polyuréthane expansée avec densité différentes de 25 à 30 kg/m³ : 3 types différents de mousse
- 2b_garnissage de l'assise en mousse polyuréthane expansée avec densité différentes de 35 à 30 kg/m³ : 2 types différents de mousse
- 3_garnissage en plumes d'oie stérilisées hypoallergéniques
- 4_garnissage en fibres acryliques
- 5_sangles élastiques
- 6_structure en métal
- 7_pied en métal chrome noir

le modèle est équipé de diverses fonctions et de mécanismes relaxants qui améliorent considérablement votre confort de couchage et d'assise

materials

- 1_cover
- 2_frame upholstered with expanded polyurethane foam in different densities from 25 to 110 kg/m³: 2 types of foams
- 2a_back cushions upholstery is in polyurethane foam in different densities from 25 to 30 kg/m³: 3 types of foams
- 2b_seat cushions upholstery is in polyurethane foam in different densities from 35 to 30 kg/m³: 2 types of foams
- 3_sterilized hypoallergenic goose-down
- 4_acrylic padding
- 5_elastic belts
- 6_metal frame
- 7_black chrome-plated metal leg

this model is equipped with various functions and relax mechanisms that significantly improve your lying and sitting comfort

materialien

- 1_bezug
- 2_polsterung aus Polyurethanschaum mit unterschiedlicher Dichte von 25 bis 110 kg/m³: 2 verschiedene Schaumstoffarten
- 2a_rückenkissenpolsterung aus Polyurethanschaum mit unterschiedlicher Dichte von 25 bis 30 kg/m³: 3 verschiedene Schaumstoffarten
- 2b_sitzkissenpolsterung aus Polyurethanschaum mit unterschiedlicher Dichte von 35 bis 110 kg/m³: 2 verschiedene Schaumstoffarten
- 3_polsterung aus sterilisierter, antiallergischen Gänsedaune
- 4_acrylpolsterung
- 5_hochelastische Gurtbänder
- 6_metallgestell
- 7_schwarz verchromter Metallfuß

das Modell ist mit verschiedene Funktions- und Relax Mechanismen ausgestattet, die Ihre Liege- und Sitzkomfort erheblich verbessern

cierre imbottiti srl

via giovanni ansaldo, 2
47122 villa selva, forlì (fc), italy
t. (+39) 0543 785911
f. (+39) 0543 782493
info@cierreimbottiti.com

www.cierreimbottiti.com



designer: Anke Reuter

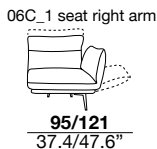
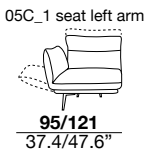
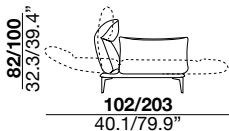
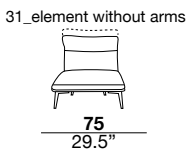
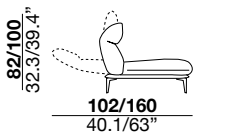
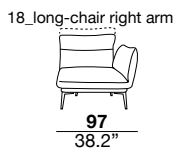
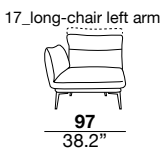
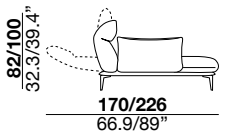
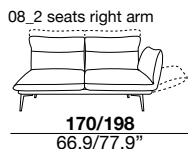
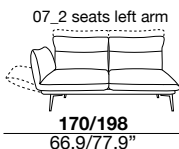
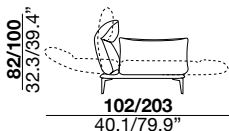
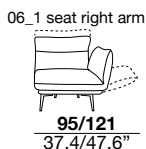
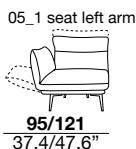
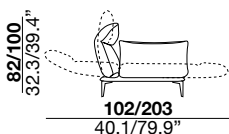
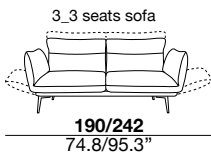
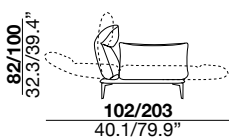

divano multi-funzionale con struttura in metallo. Lo schienale in poliuretano espanso è dotato di un meccanismo reclinabile. La seduta ed il bracciolo imbottiti in poliuretano espanso, sono dotati di un meccanismo che consente di ruotare la seduta per ottenere una posizione relax. I poggiatesta sono imbottiti in piuma d'oca anallergica. I piedi in metallo sono cromati neri.

17-18 chaise-longue abbinabile solo con elem. 07-08. Elementi 05C, 06C, 31 non disponibili indipendenti.